

## Installation & Assembly

1. Carefully remove packaging, avoid damage to the poles and fittings.
2. Offer pole up to the window and centralise over width to determine correct length (remove the rings for ease). Remember to allow sufficient length either side to accommodate the curtains when opened.
3. Make a mark on the wall approximately 100mm (4") out from the edge of the window to situate the brackets (Fig. 1).

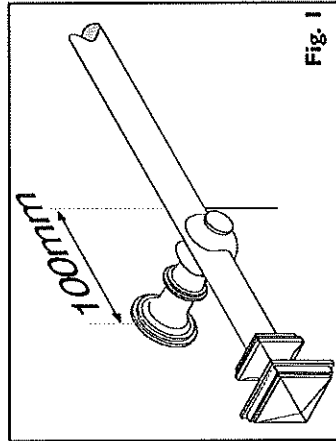

Fig. 1

Use a spirit level to mark the top line of the brackets.

4. Position the bracket plates on the wall and mark the three holes on the wall for drilling, Fig. 2.

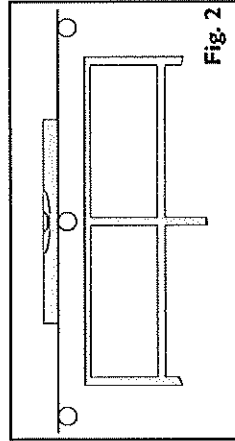

Fig. 2

5. Using the wall plugs and screws provided fix the brackets securely, Fig. 3. Alternative wall fixings should be used where necessary.

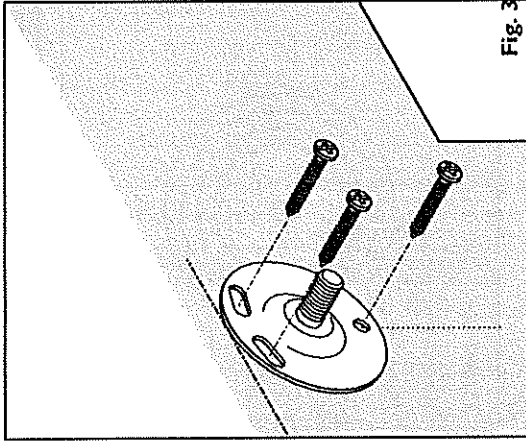

Fig. 3

6. When you have fixed the bracket plates, screw the brackets on to the mounting brackets Fig. 4. Ensure the cups are facing upwards.

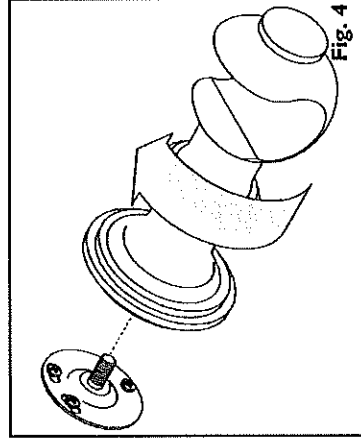

Fig. 4

## Shortening the Pole

If it is necessary to shorten the pole you should mark the required length with a pencil and using a mitre saw, to ensure a square cut, cut to length.

Where there are two poles cut equal amounts off each final end. A template is provided on the back of these instructions, to mark the centre of the pole as shown in Fig. 5.

Once you have finished cutting the pole you need to drill pilot holes to a depth of at least 30mm using a 3mm wood drill. This will allow you to fix the finials in place.

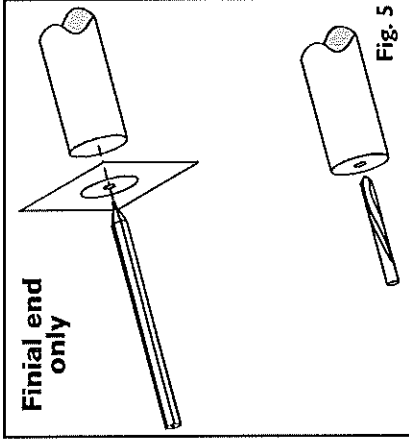

Fig. 5

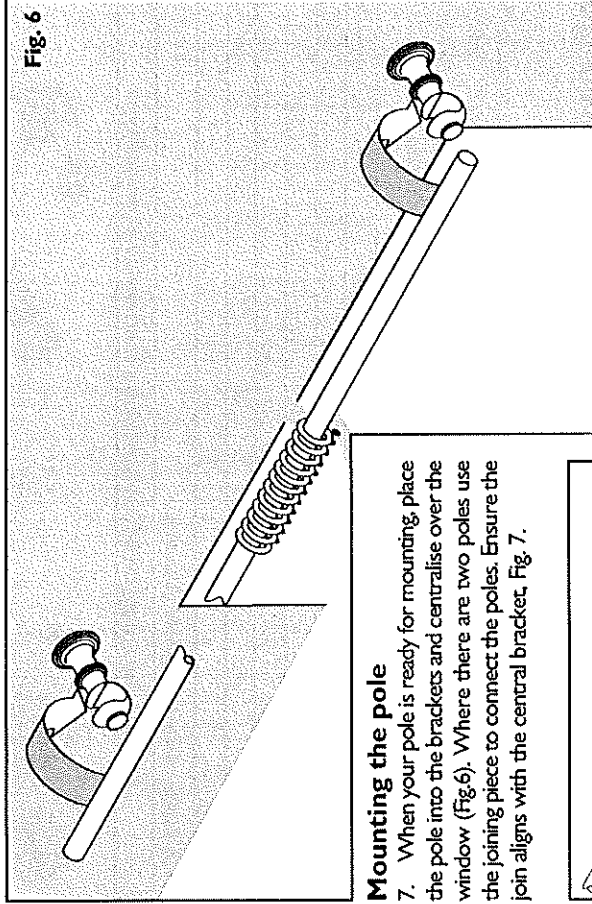

Fig. 6

## Mounting the pole

7. When your pole is ready for mounting, place the pole into the brackets and centralise over the window (Fig. 6). Where there are two poles use the joining piece to connect the poles. Ensure the join aligns with the central bracket, Fig. 7.

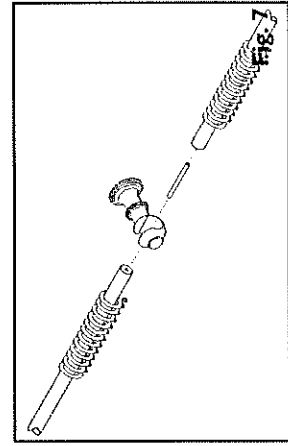

Fig. 7

8. Before assembling the finials slide on the required number of curtain rings. For two part poles place equal amounts of rings on each pole.