

Installation and Assembly

1. Carefully remove all the packaging, taking care not to damage the track.

2. When you have decided the location of the rail mark out the position of the fixing line, 10cm above the window recess and allow 15cm either side for the curtains to stack back as shown in Fig. 1.

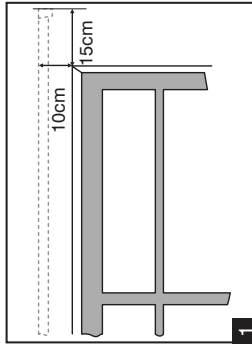

1

Mounting Rail end brackets

3. Take a rail end bracket, undo the small screw and separate the two parts (Fig. 2). This will make it easier to reach the screws to fix them to the batten or wall.

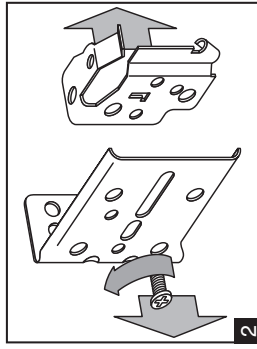

2

4. Holding the bracket up to the fixing line, mark off the holes for the screws with a pencil (Fig. 3). If you are mounting on to a batten drill a 2mm diameter hole in the batten to a depth of 30mm. Use a spirit level to ensure the holes are straight. Repeat on the other side of the window.

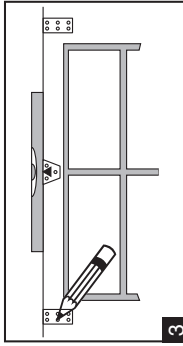

3

5. Once you have marked the position of the brackets drill holes and using the appropriate wall plugs fix the brackets as shown in Fig. 4.

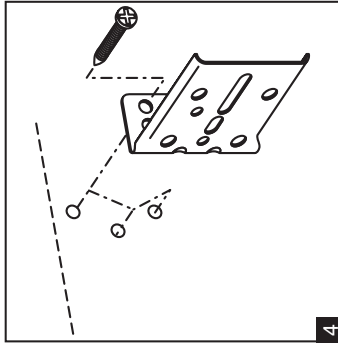

4

6. Reassemble the rail end bracket, ensure that the small screw is securely fixed (Fig. 5).

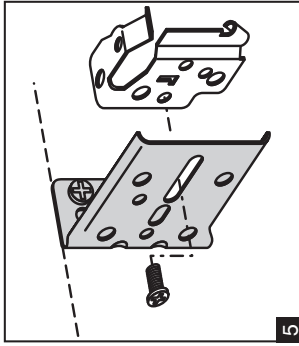

5

Attaching the Curtain Track

7. Once the brackets are securely fixed, insert one end of the curtain track 'projection' 'lug into the receiving channel of the end bracket and push the front of the track to click-close it in position (Fig. 6).

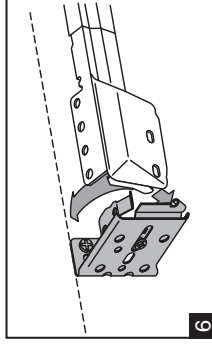

6

Intermediate Support Brackets

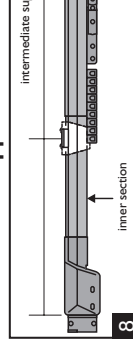

inner section

intermediate supports evenly spaced

8

10. If you extend the curtain track horizontally by more than 300mm, you should use one or more intermediate support brackets. If you use one support bracket it should be positioned at the midpoint of the window recess. If you use more than one bracket, they should be evenly spaced along the track (Fig. 8).

11. When you have marked the position of the brackets, remove the whole track from the rail end brackets. Hold the brackets up to the fixing line, mark off the holes for the screws with a pencil. If you are mounting on to a batten drill a 2mm diameter hole in the batten to a depth of 30mm.

12. Once you have marked the position of the brackets, drill holes and fix the brackets securely (Fig. 9). If you are fixing directly to a wall use the appropriate wall plugs to fix the brackets.

8. Repeat the procedure on the other end, you may need to extend the track.

9. You can adjust the position of the track relative to the wall by loosening the small locking screws in the end brackets and the pulling the track out to suit (Fig. 7). Re-secure the screw upon completion.

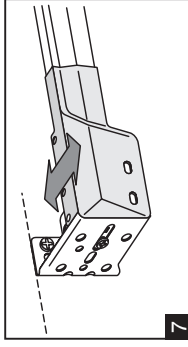

7

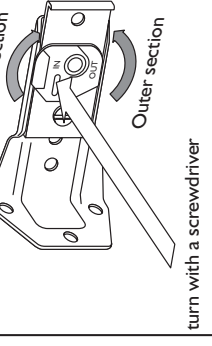

turn with a screwdriver

11

14. Underneath the support brackets you will find a locking clamp. You need a flat screwdriver to rotate the clamp (Fig. 11).

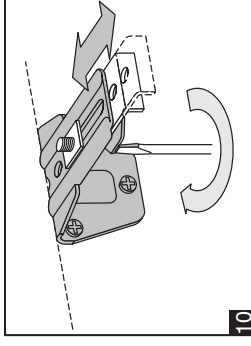

10

Centring the Master Slides

17. Once you have fitted the overlap and underlap arms, centre the Master Slides.

18. Ensure that both slides are in the fully open position.

19. Pull the outer draw cord to move the overlap Master Slide to its end of the track (Fig. 14).

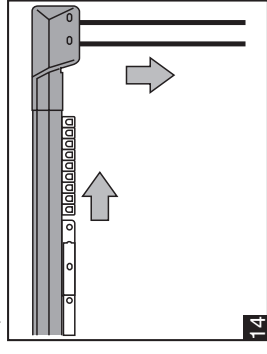

14

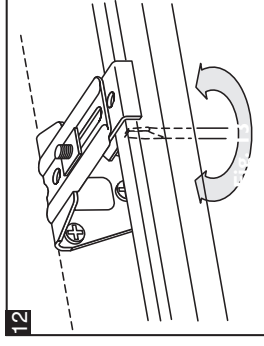

12

15. When you clip the bracket over the front of the outer section of the track, you must turn the locking clamp anti-clockwise. If you fit the bracket over the inner (narrower) section of the track you must turn the locking clamp clockwise to engage with the track correctly (Fig. 12).

20. Hold both cords taut and move the underlap Master Slide by hand to its end of the track.

21. Lift up the cord off the top peg behind the left hand side or underlap Master Slide, twist it once and place the loop created under the lower peg as shown in Fig. 15.

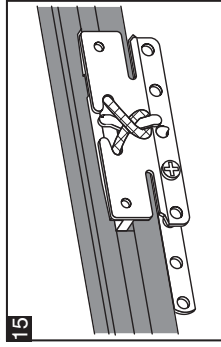

22. Pull the outside cord to tighten the loop. Check to ensure the Master Slides are still centred and adjust again if necessary.

Fitting a Tension Pulley

23. Using the two screws supplied, fix the tension pulley to the floor, skirting board or window sill, directly in line with the pull cord as shown (Fig. 16).

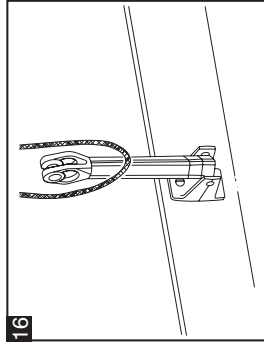

24. Extend the neck of the pulley and secure in higher position using a pin or small nail. Remove the central barrel of the pulley by pulling it down and then out (Fig. 17a). Place the cord inside the pulley and replace the barrel ensuring it clicks into place (Fig. 17b).

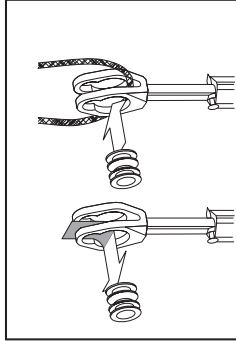

17a

25. Take up the slack of the cord and tie a knot behind the masterslide arm. Remove the pin or nail from the pulley, the cord will now be fully tensioned. If there is insufficient tension in the cord, reduce the cord length by adjusting the knot behind the masterslide arm (Fig. 18).

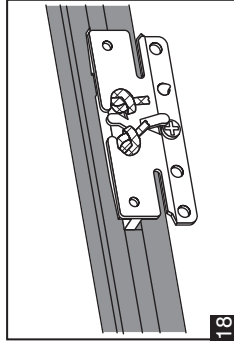

18

26. If the cord becomes twisted, simply rotate the head of the pulley to untwist it (Fig. 19). The track is now ready to accept curtains.

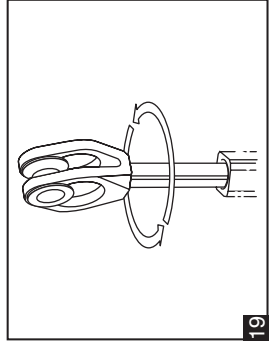

19

WARNING Young children can strangle in the loop of pull cords, chains and tapes, and cords that operate window coverings. They can also wrap cords around their necks. To avoid strangulation and entanglement, keep cords out of the reach of young children. Move beds, cots and furniture away from window coverings.

Safety

- Only use a step ladder or stable chair to reach fixing height.
- Do not over reach. Always move the step ladder or chair so that you are in a safe working position.
- Do not hold or lean on the track to support your weight.
- Use two people for the installation of longer tracks.
- Take care when using power tools, use of a Residual Current Device (RCD) is recommended.
- Always wear eye protection when drilling.
- Beware of hidden pipe runs and cables.

Care and Maintenance

Tracks should be wiped clean periodically with a warm damp cloth.

The track has been designed to run smoothly for many years, however, the occasional application of silicon polish to the roller glider channel will ensure continued high performance.

Integra Products Ltd, High Point, Sandy Hill Business Park, Sandy Way, Amington, Tamworth, Staffordshire B77 4DU
 • tel: +44 (0) 1543 267100 fax: +44 (0) 1543 267105
 • email: cas.car@integra-products.co.uk • web: www.integra-products.co.uk



Ultragliding Curtain Track

Fitting Instructions

Please read these instructions carefully and check the contents of the pack against the table, before attempting to assemble and fix this product. The fixing screws supplied are for use where a wooden batten is fixed to the wall. If you intend to fix the track directly to the wall, you must use the most appropriate wall plugs and fixings.

Tools Required: Spirit level, Tape measure, Flat bladed screwdriver, Crosshead (Phillips) screwdriver, 2mm drill bit (pilot hole for wood screws), Pencil, Step ladder.

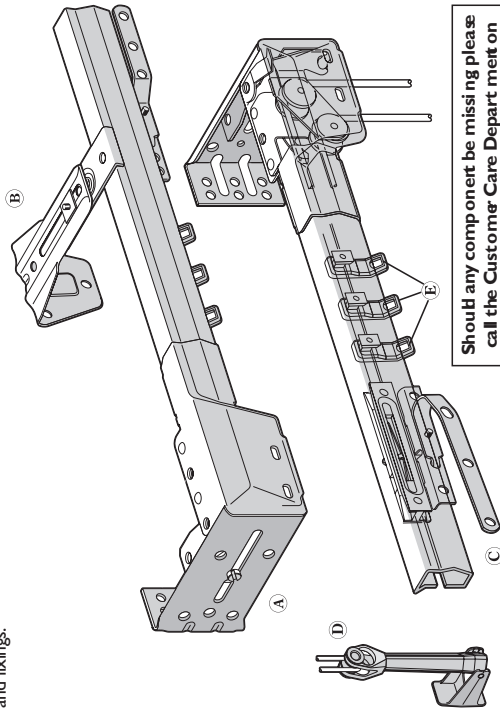

Should any component be missing please call the Customer Care Department on 0800 515493

Contents	Lengths	1.0m to 1.75m	1.2m to 2.0m	1.75m to 3.0m	2.5m to 4.0m	3.0m to 5.5m
A Rail End Bracket	2	2	2	2	2	2
B Intermediate Brackets	1	1	2	2	3	4
C Master Slide overlap arms	2	2	2	2	2	2
D Tension Pulley	1	1	1	1	1	1
E Gliders	18	20	30	40	40	56

L4541552