

1. Preparing the window

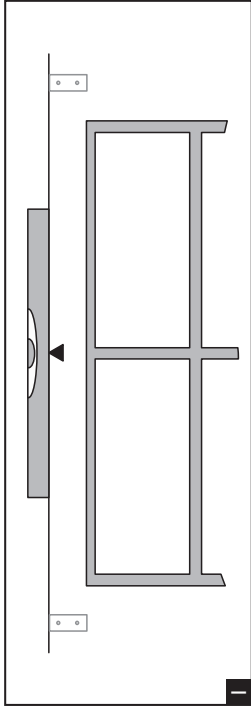

1. Use a spirit level to mark the top line of the brackets, Fig. 1.

Position pole up to the window and centralise over width to determine correct length, Fig. 2. Remember to allow sufficient length either side to accommodate the curtains when opened and the finials when fitted.

For long pole lengths you must fit intermediate support brackets at equal intervals along the pole length shown in Fig. 3.

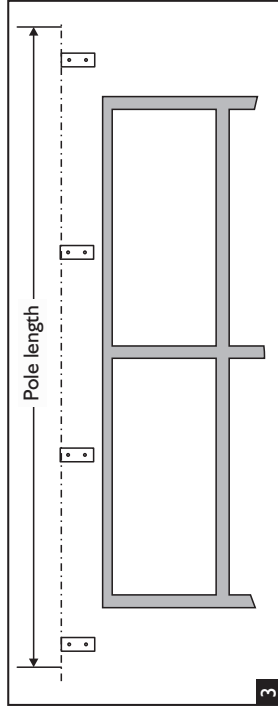
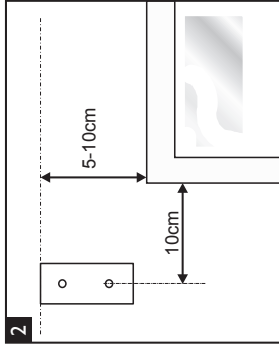

3. The pole is adjusted in length by sliding the inner pole into or out of the outer pole.

2. Fixing wall brackets

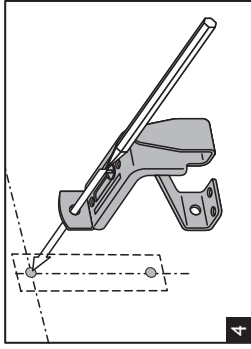

1. Position the brackets on the wall and mark the holes on the wall, Fig. 4.

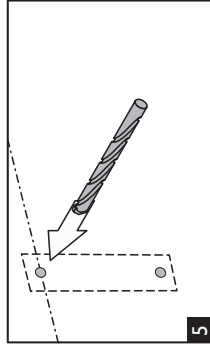

2. Drill 2mm \varnothing pilot hole if mounting on to a wooden batten. If mounting directly on to a masonry or studded wall, Fig. 5, use the appropriate drill size for the wall plug, Fig. 6. (seek guidance from local builder's store if unsure).

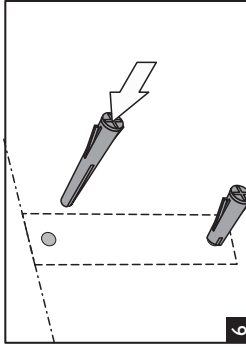

Please ensure the correct wall plugs are used to suit your wall type.

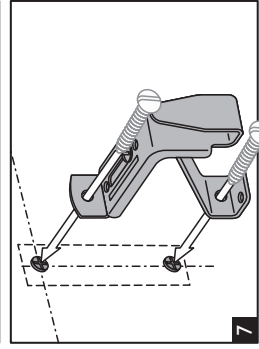

3. Using the correct screws fix the brackets securely, Fig. 6 & 7. Alternative wall fixings should be used where necessary.
4. Repeat for all the brackets required.

3. Fitting the pole

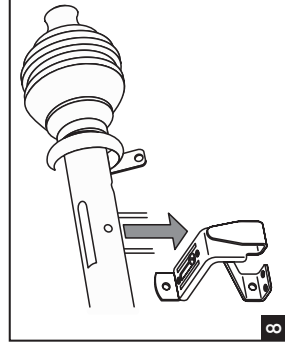

1. Extend pole to the approximate required length, slide one curtain ring to each end of the pole (next to finials) and place pole onto the wall brackets. At each end of the pole there is a hole on the underside. These holes locate on the protruding lugs of each end bracket arm (Fig. 8).

4. Fixing intermediate wall brackets

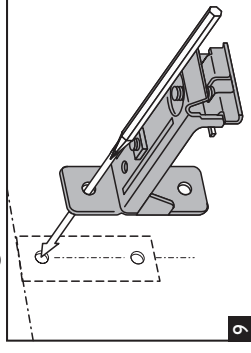

1. Place the pole on the outer brackets and position the intermediate bracket and mark the holes on the wall, Fig. 9.

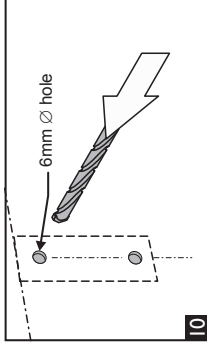

2. Drill 2mm \varnothing pilot hole if mounting on to a wooden batten or 6mm \varnothing if mounting directly on to a masonry or studded wall Fig. 10.

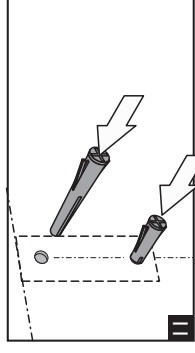

Please ensure the correct wall plugs are used to suit your wall type.

3. If mounting directly onto a masonry or studded wall insert suitable wall plugs, Fig. 11.

4. Using the correct screws fix the brackets securely, Fig. 12. Alternative wall fixings should be used where necessary.

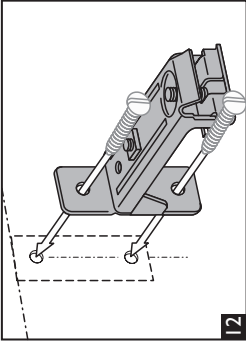

12

5. Attach supports by hanging the clip in the channel of the pole. The bracket is extendable by loosening the small screw underneath and sliding the bracket forwards or backwards.

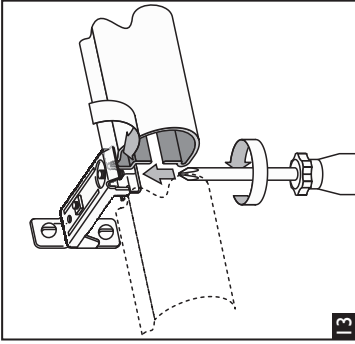

13

5. Centring the Master slides

- 1 Ensure that both Master Slides are in the fully open position.
- 2 Pull outer draw cord to move overlap Master Slide to its end of the rail. Holding both cords taut, move the underlap Master Slide to its end of the rail.
- 3 Lift the cord up off the top peg behind the left hand master slide, twist it once and place the loop created over the lower peg as shown (Fig. 14).
- 4 Gently pull the one cord to tighten the loop. Check to ensure the Master slides are still centred and adjust if necessary.

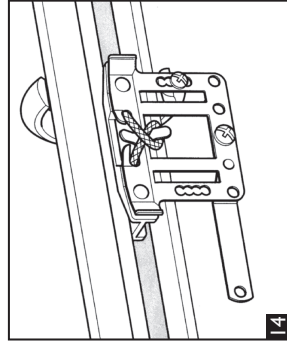

14

8. Fitting a Tension Pulley

Fix the tension pulley to the floor, skirting board or window sill, directly in line with the pull cord as shown (Fig. 15).

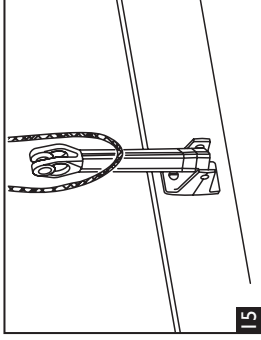

15

Extend the neck of the pulley and secure in higher position using a pin or small nail. Remove the central barrel of the pulley by pulling it down and then out (Fig. 16a). Place the cord inside the pulley and replace the barrel ensuring it clicks into place (Fig. 16b).

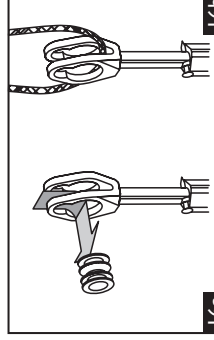

16a

16b

Take up the slack of the cord and tie a knot behind the masterside arm. Remove the pin or nail from the pulley, the cord will now be fully tensioned. If there is insufficient tension in the cord, reduce the cord length by adjusting the knot behind the masterside arm (Fig. 17).

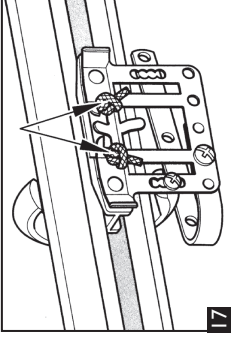

17

If the cord becomes twisted, simply rotate the head of the pulley to untwist it (Fig. 18). The track is now ready to accept curtains.

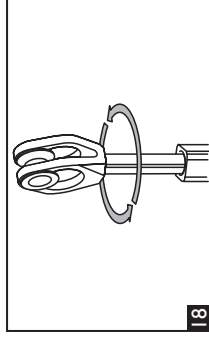

18

Safety

- Only use a step ladder or stable chair to reach the fixing height.
- Do not over reach. Always move the stepladder or chair, so that you are in a safe working position.
- Do not hold or lean on the pole to support your weight.
- Use two people for the installation of longer poles.
- Take care when using power tools, use of a Residual Current Device (RCD) is recommended.
- Always wear eye protection when drilling.
- Beware of hidden pipe runs and cables.

Integra Products Ltd, High Point, Sandy Hill Business Park, Sandy Way, Amington, Tamworth, Staffordshire B77 4DU
 • tel: +44 (0)1543 267100 • fax: +44 (0)1543 267105
 • email: cus.care@integra-products.co.uk • web: www.integra-products.co.uk



Royal Orb Curtain Pole

Fitting Instructions

Please read these instructions carefully and check the contents of the pack against the table below before attempting to assemble and fix this product. The fixing screws supplied are for use where a wooden batten is fixed to the wall. If you intend to fix the pole directly to the wall, you must use the most appropriate wall plugs and fixings.

Tools Required: Spirit level, Tape measure, Flat bladed screwdriver, Crosshead (Phillips) screwdriver, 2mm drill bit (pilot hole for wood screws), 6mm drill bit for fixing batten or track to wall (if required), Pencil, Step ladder.

Please ensure the correct wall plugs are used to suit your wall type.

WARNING Young children can strangle in the loop of pull cords, chains and tapes, and cords that operate window coverings. They can also wrap cords around their necks. To avoid strangulation and entanglement, keep cords out of the reach of young children. Move beds, cots and furniture away from window coverings.

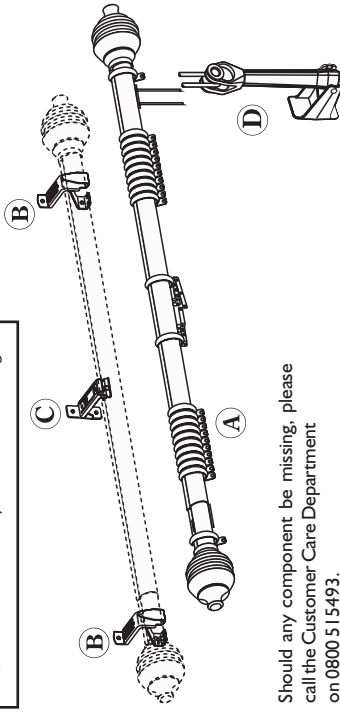

Should any component be missing, please call the Customer Care Department on 0800 515493.

| Contents | Lengths (m) ▷ | 0.96m - 1.68m | 1.68m - 3.05m | 2.13m - 3.96m |
|------------------------------|---------------|---------------|---------------|---------------|
| A Ring slides | 16 | 26 | 32 | |
| B End brackets (inc. screws) | 2 | 2 | 2 | |
| C Intermediate supports | 1 | 2 | 3 | |
| D Tension Pulley | 1 | 1 | 1 | 1 |

L4548/jsz