

# Vertical Blinds Fitting & Operating Instructions

**Please read these instructions before  
attempting to fit your blind.**

Loveless Cook Blinds Ltd, Burnet Road, Sweetbriar Ind Estate, Norwich, NR3 2BS



# Vertical Blinds Fitting & Operating Instructions

**Please read these instructions before  
attempting to fit your blind.**

Loveless Cook Blinds Ltd, Burnet Road, Sweetbriar Ind Estate, Norwich, NR3 2BS



# vertical blinds

## fitting instructions

### fittings

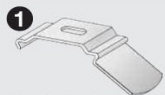

1 Top fix brackets: min 2

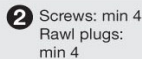

2 Screws: min 4  
Rawl plugs: min 4



3 Face fix brackets (with short screws): min 2

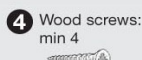

4 Wood screws: min 4



5 Weight



6 Stabilising chains: 2

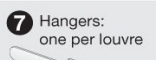

7 Hangers: one per louvre



8 Double Cord and Chain Tidy



9 Blind: 1

### Outside Recess

If fitting the blind outside the window, measurements (C) will need to be the same. To work out (C), simply minus (B) from (A) and divide the answer by two. Follow instructions for FACE FIXING

### Inside recess

Decide whether to FACE or TOP FIX. FACE FIX to fit the bracket to the window frame. TOP FIX to the lintel if the window frame is uPVC, or if there are any obstructions, e.g. window handles.

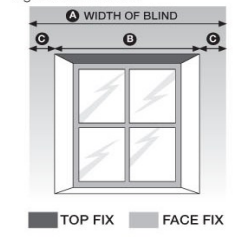

step one

### Face Fixing

Lightly screw short screws into place. Position brackets approx 5cm from the ends of the headrail. Mark holes A and screw brackets into place.

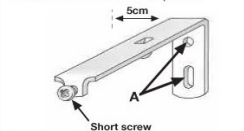

### Top Fixing

Measure and mark the distance any handles protrude. Then, using the louvre hanger, find and mark the fitting position A. Drill brackets into position 5cm away from the side walls.

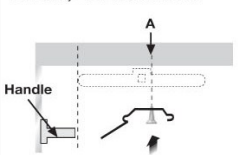

step two

### Face Fixing

With carriage C closest to you, hook the back of the headrail into the brackets. Tighten the short screws to lock the headrail into place.

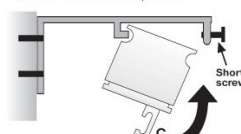

### Top Fixing

Tilt and hook the front of the headrail (carriage C closest to you) into the bracket. Press the back up into position until it clicks. Push B up to release blind.

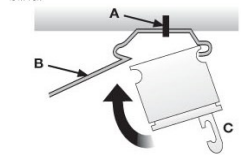

step three

Once headrail is fitted, break open the plastic protecting the roll of louvres. Keeping the louvres in a roll, peel off one at a time and insert a hanger A in each. Ensure all hangers are positioned the same way up. Clip the hangers on to the carriage, ensuring the fabric overlaps are at the back. Turn hanger A upside down to shorten drop of louvres if desired.

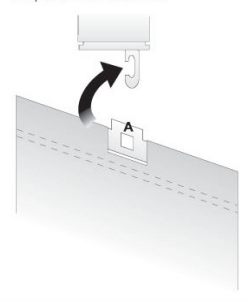

step four

Starting from one end, snap the beaded chain on to the bottom weights on both sides.

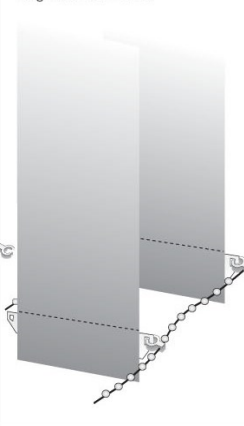

step five

Double Cord and Chain Tidy Allows you to house both chain and cord where both are used and keep them taugth but usable.

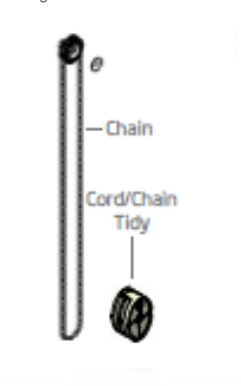

step six

### WARNING

In the interest of safety it is advisable to keep all pull cords and bead chains out of the reach of children to prevent strangulation

The safety device provided should be fitted in areas where children and/or vulnerable people may be present.

Simply loop the cord and chain and push down on the tensioning studs and fix to wall.



# vertical blinds

## fitting instructions

### fittings

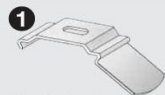

1 Top fix brackets: min 2

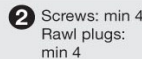

2 Screws: min 4  
Rawl plugs: min 4



3 Face fix brackets (with short screws): min 2

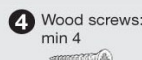

4 Wood screws: min 4



5 Weight



6 Stabilising chains: 2

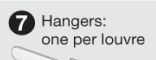

7 Hangers: one per louvre



8 Double Cord and Chain Tidy



9 Blind: 1

### Outside Recess

If fitting the blind outside the window, measurements (C) will need to be the same. To work out (C), simply minus (B) from (A) and divide the answer by two. Follow instructions for FACE FIXING

### Inside recess

Decide whether to FACE or TOP FIX. FACE FIX to fit the bracket to the window frame. TOP FIX to the lintel if the window frame is uPVC, or if there are any obstructions, e.g. window handles.

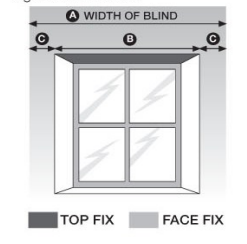

step one

### Face Fixing

Lightly screw short screws into place. Position brackets approx 5cm from the ends of the headrail. Mark holes A and screw brackets into place.

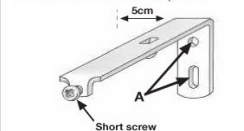

### Top Fixing

Measure and mark the distance any handles protrude. Then, using the louvre hanger, find and mark the fitting position A. Drill brackets into position 5cm away from the side walls.

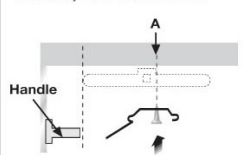

step two

### Face Fixing

With carriage C closest to you, hook the back of the headrail into the brackets. Tighten the short screws to lock the headrail into place.

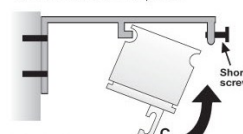

### Top Fixing

Tilt and hook the front of the headrail (carriage C closest to you) into the bracket. Press the back up into position until it clicks. Push B up to release blind.

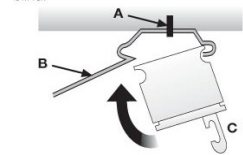

step three

Once headrail is fitted, break open the plastic protecting the roll of louvres. Keeping the louvres in a roll, peel off one at a time and insert a hanger A in each. Ensure all hangers are positioned the same way up. Clip the hangers on to the carriage, ensuring the fabric overlaps are at the back. Turn hanger A upside down to shorten drop of louvres if desired.

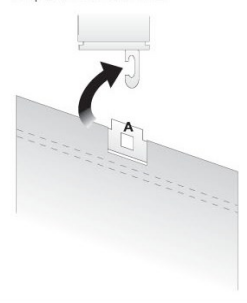

step four

Starting from one end, snap the beaded chain on to the bottom weights on both sides.

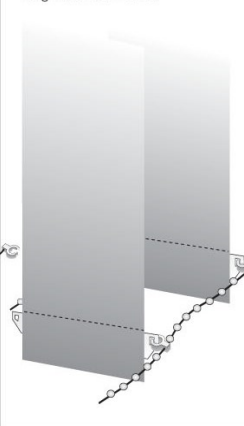

step five

Double Cord and Chain Tidy Allows you to house both chain and cord where both are used and keep them taugth but usable.

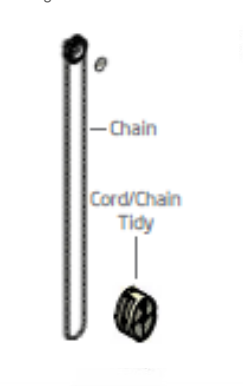

step six

### WARNING

In the interest of safety it is advisable to keep all pull cords and bead chains out of the reach of children to prevent strangulation

The safety device provided should be fitted in areas where children and/or vulnerable people may be present.

Simply loop the cord and chain and push down on the tensioning studs and fix to wall.



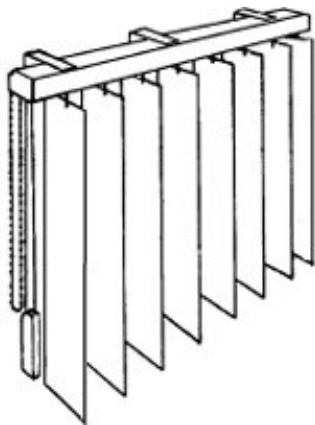
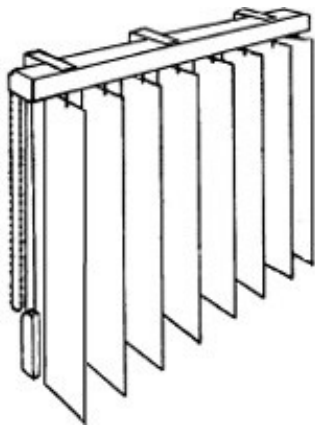

# Vertical Blinds Fitting & Operating Instructions

**Please read these instructions before  
attempting to fit your blind.**

Loveless Cook Blinds Ltd, Burnet Road, Sweetbriar Ind Estate, Norwich, NR3 2BS



# Vertical Blinds Fitting & Operating Instructions

**Please read these instructions before  
attempting to fit your blind.**

Loveless Cook Blinds Ltd, Burnet Road, Sweetbriar Ind Estate, Norwich, NR3 2BS



# vertical blinds

## fitting instructions

### fittings

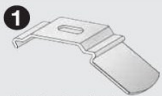

Top fix brackets:  
min 2

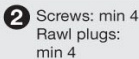

2 Screws: min 4  
Rawl plugs:  
min 4



Face fix brackets  
(with short screws):  
min 2



4 Wood screws:  
min 4

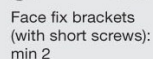

5 Weight

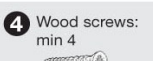

6 Stabilising  
chains: 2

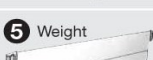

7 Hangers:  
one per louvre



8 Double Cord and Chain Tidy

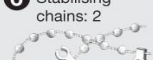

9 Blind: 1

### Outside Recess

If fitting the blind outside the window, measurements (C) will need to be the same. To work out (C), simply minus (B) from (A) and divide the answer by two. Follow instructions for FACE FIXING

### Inside recess

Decide whether to FACE or TOP FIX. FACE FIX to fit the bracket to the window frame. TOP FIX to the lintel if the window frame is uPVC, or if there are any obstructions, e.g. window handles.

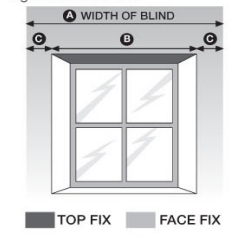

step one

### Face Fixing

Lightly screw short screws into place. Position brackets approx 5cm from the ends of the headrail. Mark holes A and screw brackets into place.

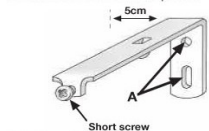

### Top Fixing

Measure and mark the distance any handles protrude. Then, using the louvre hanger, find and mark the fitting position A. Drill brackets into position 5cm away from the side walls.

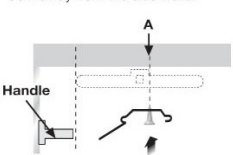

step two

### Face Fixing

With carriage C closest to you, hook the back of the headrail into the brackets. Tighten the short screws to lock the headrail into place.

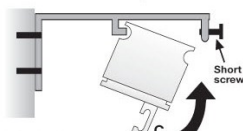

### Top Fixing

Tilt and hook the front of the headrail (carriage C closest to you) into the bracket. Press the back up into position until it clicks. Push B up to release blind.

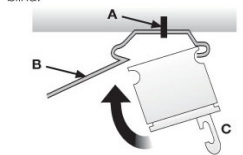

step three

Once headrail is fitted, break open the plastic protecting the roll of louvres. Keeping the louvres in a roll, peel off one at a time and insert a hanger A in each. Ensure all hangers are positioned the same way up. Clip the hangers on to the carriage, ensuring the fabric overlaps are at the back. Turn hanger A upside down to shorten drop of louvres if desired.

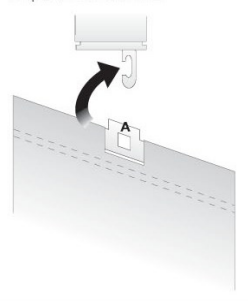

step four

Starting from one end, snap the beaded chain on to the bottom weights on both sides.

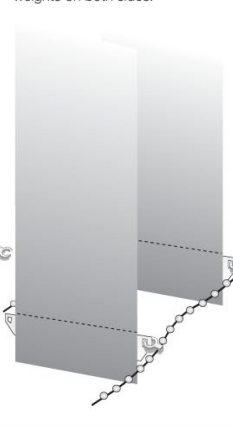

step five

Double Cord and Chain Tidy Allows you to house both chain and cord where both are used and keep them taugth but usable.

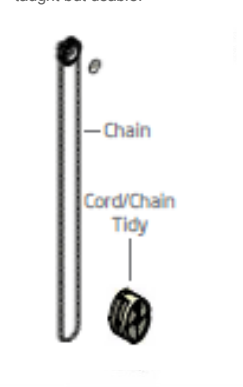

step six

### WARNING

In the interest of safety it is advisable to keep all pull cords and bead chains out of the reach of children to prevent strangulation

The safety device provided should be fitted in areas where children and/or vulnerable people may be present.

Simply loop the cord and chain and push down on the tensioning studs and fix to wall.



# vertical blinds

## fitting instructions

### fittings

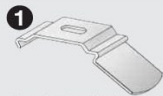

Top fix brackets:  
min 2

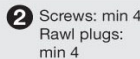

2 Screws: min 4  
Rawl plugs:  
min 4



Face fix brackets  
(with short screws):  
min 2



4 Wood screws:  
min 4

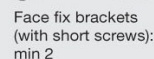

5 Weight

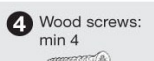

6 Stabilising  
chains: 2

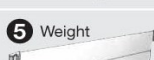

7 Hangers:  
one per louvre



8 Double Cord and Chain Tidy

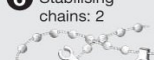

9 Blind: 1

### Outside Recess

If fitting the blind outside the window, measurements (C) will need to be the same. To work out (C), simply minus (B) from (A) and divide the answer by two. Follow instructions for FACE FIXING

### Inside recess

Decide whether to FACE or TOP FIX. FACE FIX to fit the bracket to the window frame. TOP FIX to the lintel if the window frame is uPVC, or if there are any obstructions, e.g. window handles.

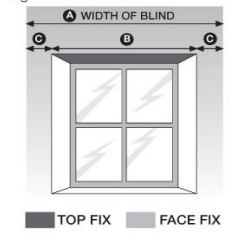

step one

### Face Fixing

Lightly screw short screws into place. Position brackets approx 5cm from the ends of the headrail. Mark holes A and screw brackets into place.

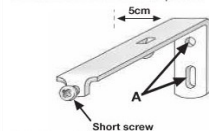

### Top Fixing

Measure and mark the distance any handles protrude. Then, using the louvre hanger, find and mark the fitting position A. Drill brackets into position 5cm away from the side walls.

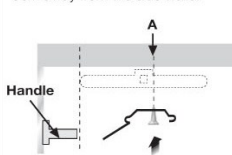

step two

### Face Fixing

With carriage C closest to you, hook the back of the headrail into the brackets. Tighten the short screws to lock the headrail into place.

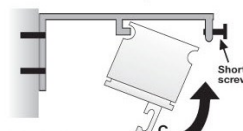

### Top Fixing

Tilt and hook the front of the headrail (carriage C closest to you) into the bracket. Press the back up into position until it clicks. Push B up to release blind.

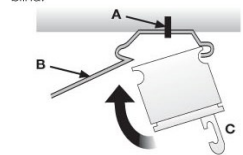

step three

Once headrail is fitted, break open the plastic protecting the roll of louvres. Keeping the louvres in a roll, peel off one at a time and insert a hanger A in each. Ensure all hangers are positioned the same way up. Clip the hangers on to the carriage, ensuring the fabric overlaps are at the back. Turn hanger A upside down to shorten drop of louvres if desired.

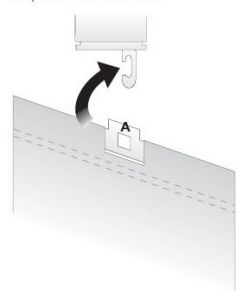

step four

Starting from one end, snap the beaded chain on to the bottom weights on both sides.

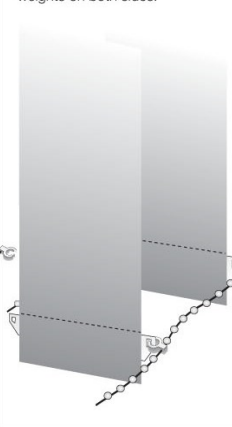

step five

Double Cord and Chain Tidy Allows you to house both chain and cord where both are used and keep them taugth but usable.

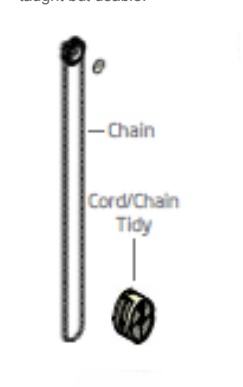

step six

### WARNING

In the interest of safety it is advisable to keep all pull cords and bead chains out of the reach of children to prevent strangulation

The safety device provided should be fitted in areas where children and/or vulnerable people may be present.

Simply loop the cord and chain and push down on the tensioning studs and fix to wall.

